

# 房间布局图

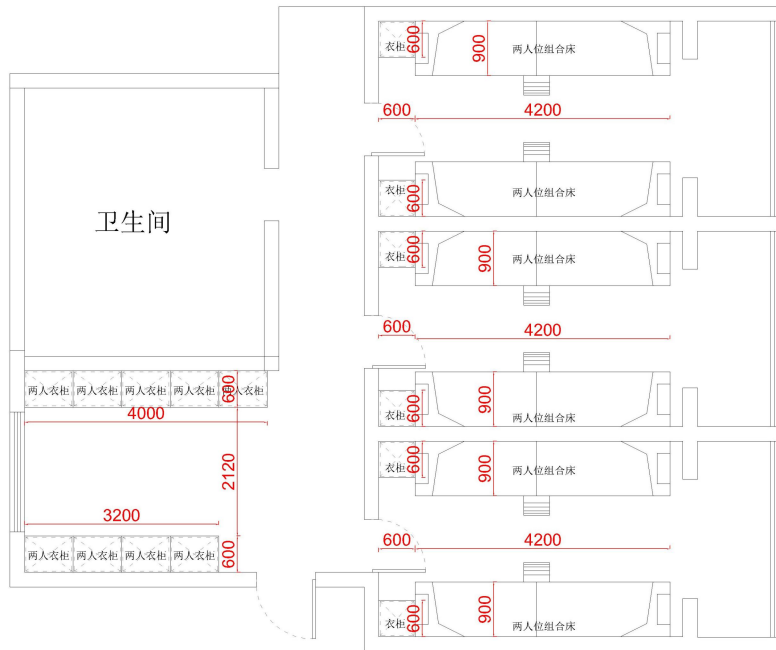

兰馨苑二栋 1 单元 101---601 套间

布局图 1

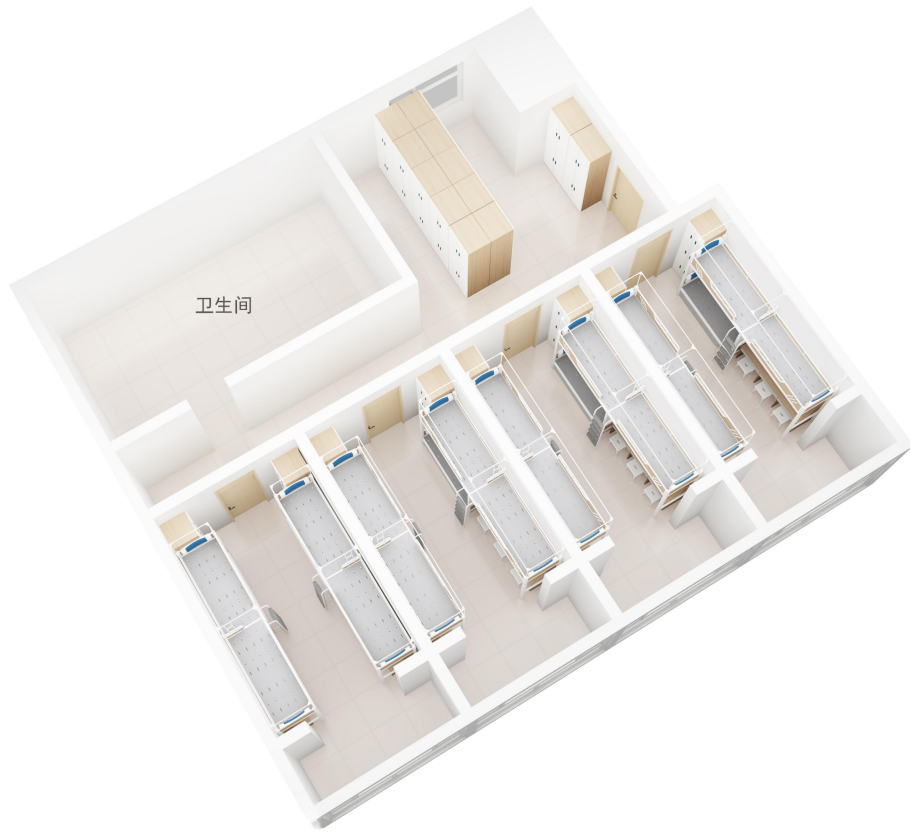
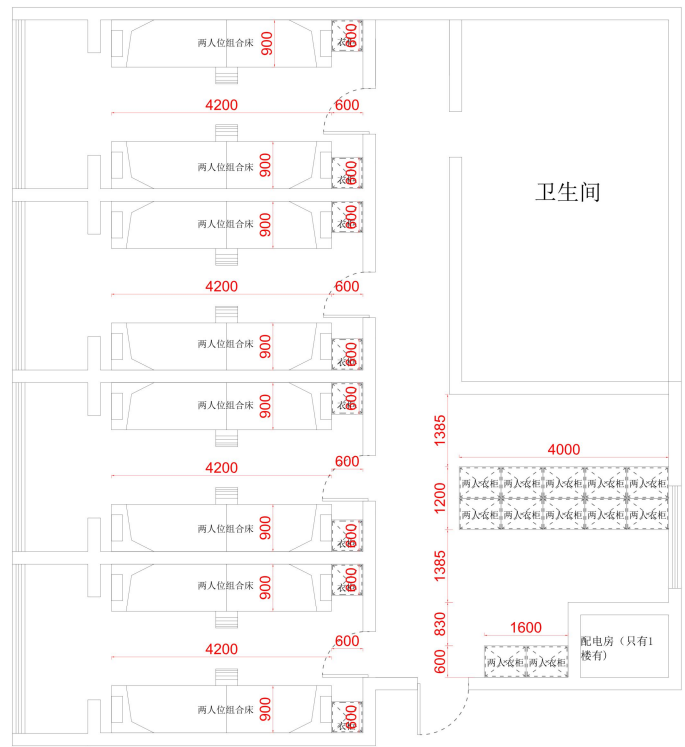

兰馨苑二栋 1 单元 102 套间

布局图 2

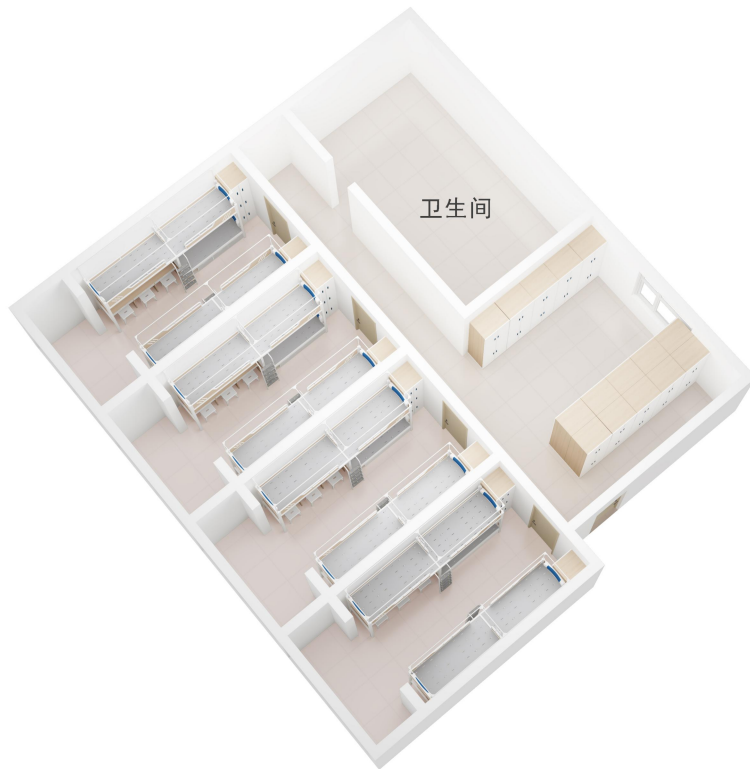
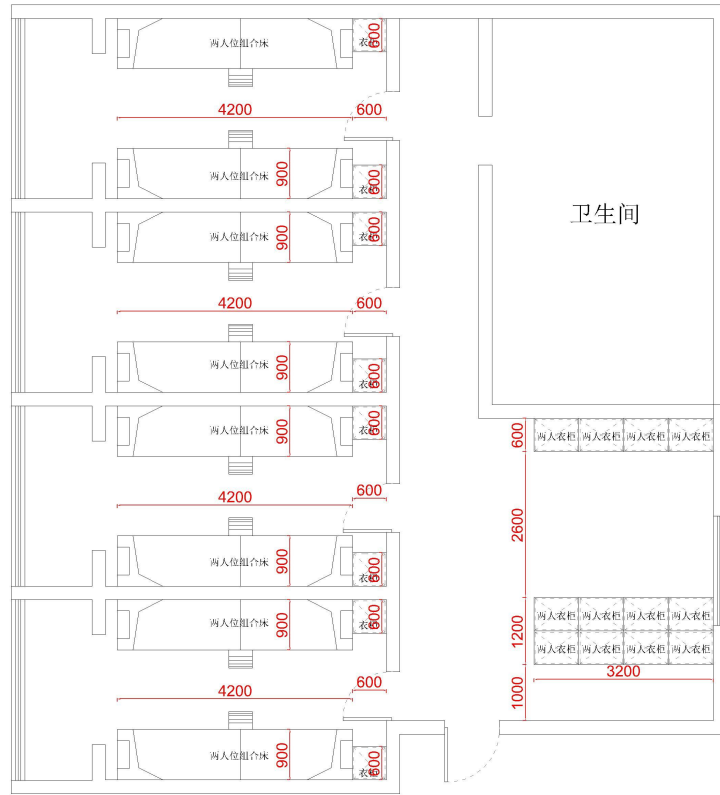

馨苑二栋 1 单元 202---602 套间

布局图 3

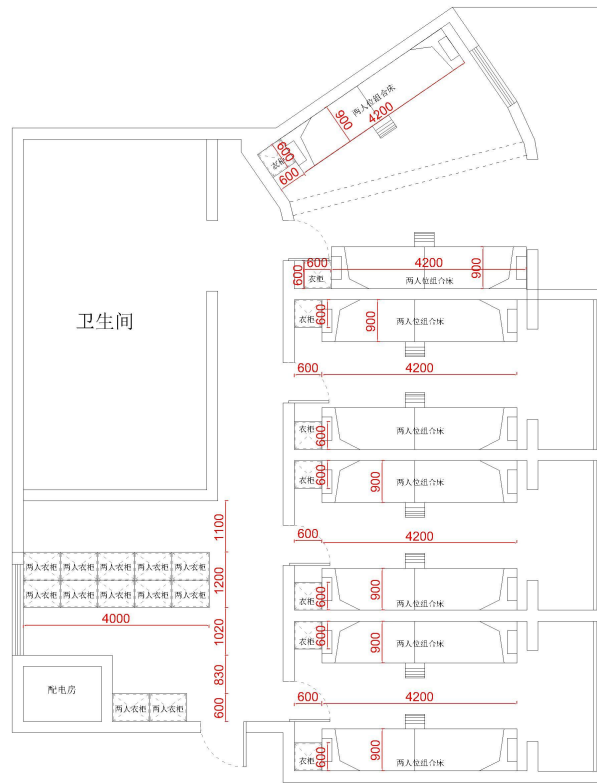

兰馨苑二栋 2 单元 103 套间

布局图 4

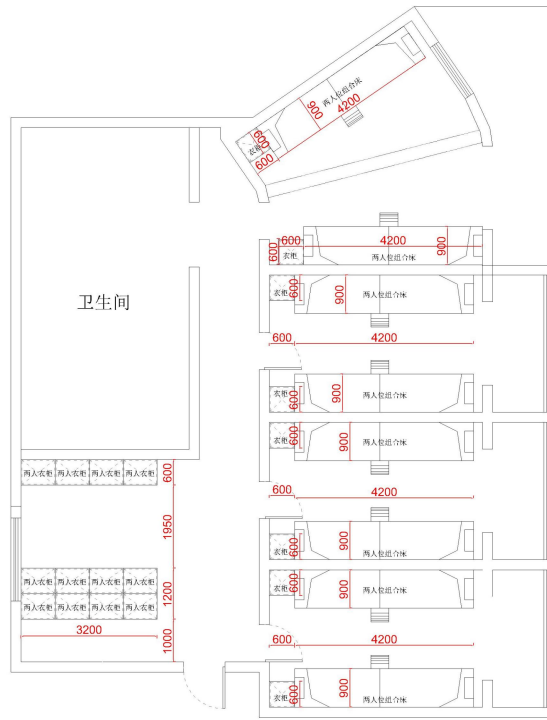

兰馨苑二栋 2 单元 203-603 套间

布局图 5

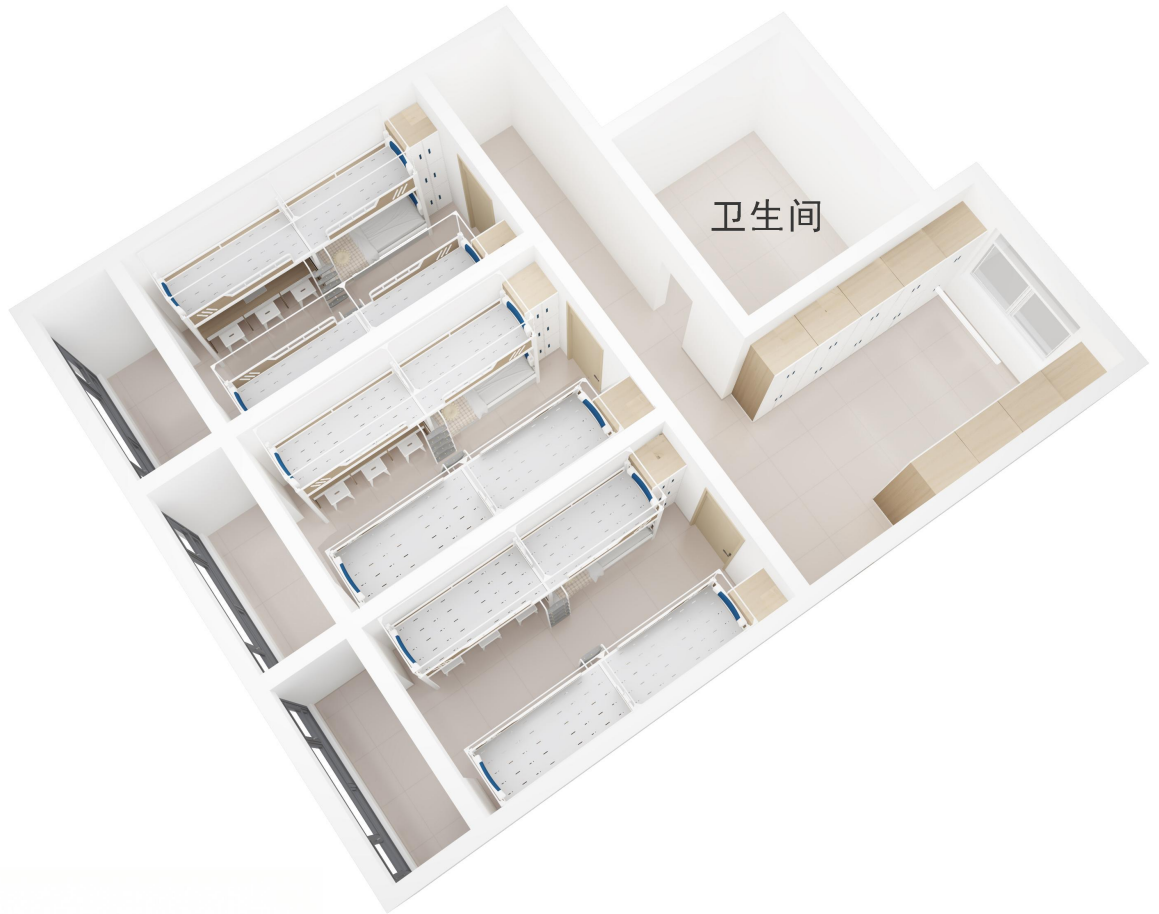
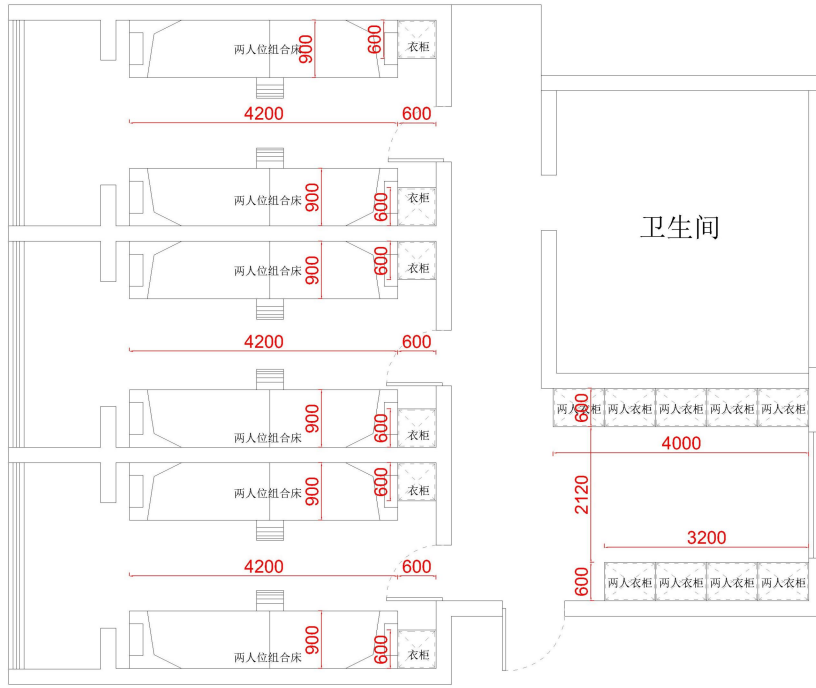

兰馨苑二栋 2 单元 104-604 套间

布局图 6

# 产品效果图





## 产品线稿图

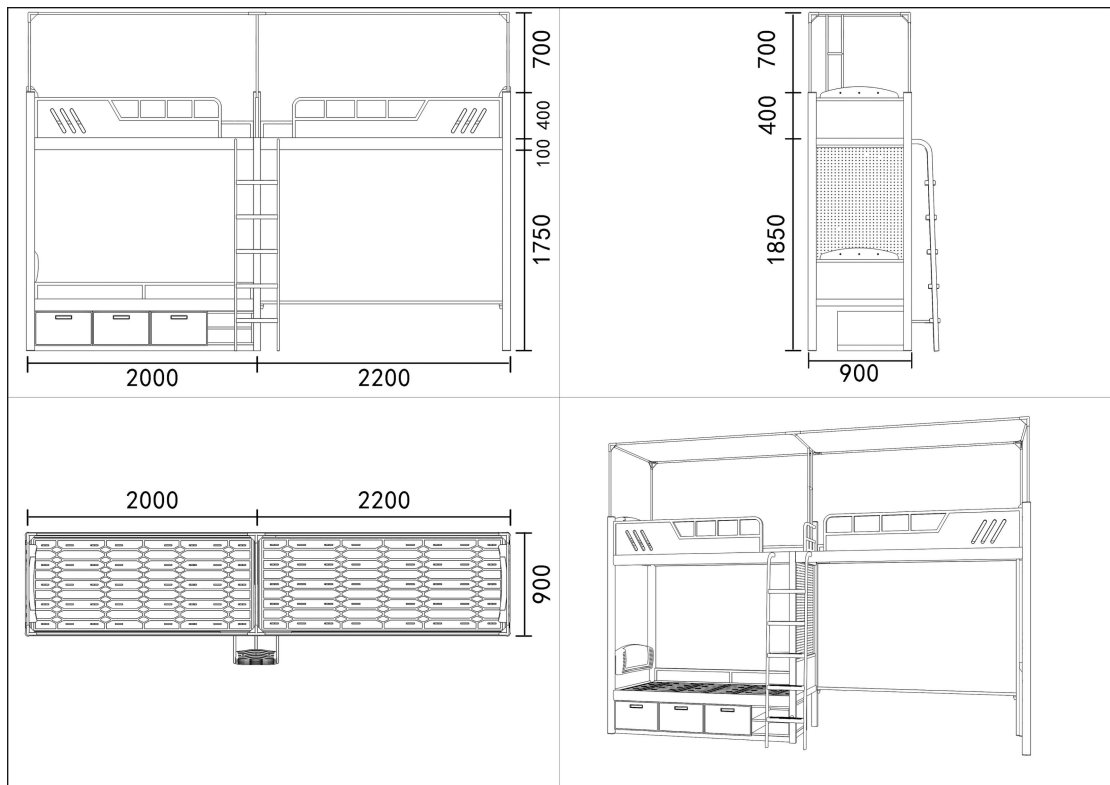

## 二上铺一下铺高架床

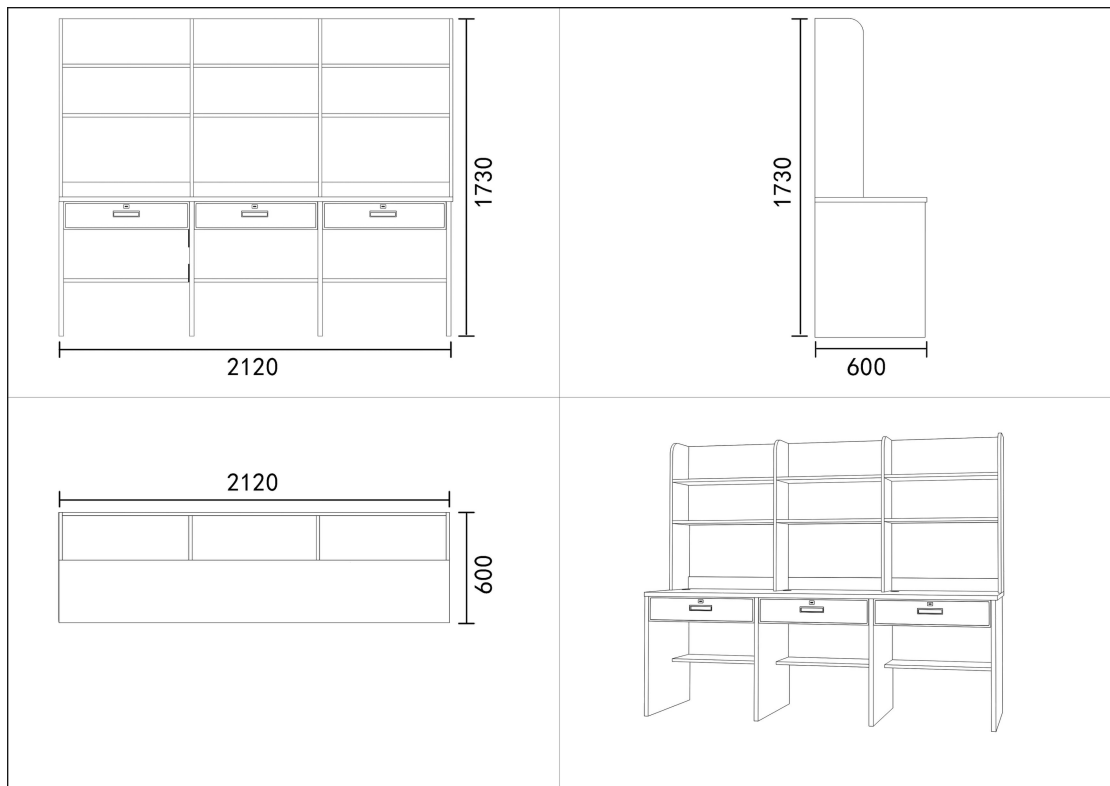

## 三人书桌

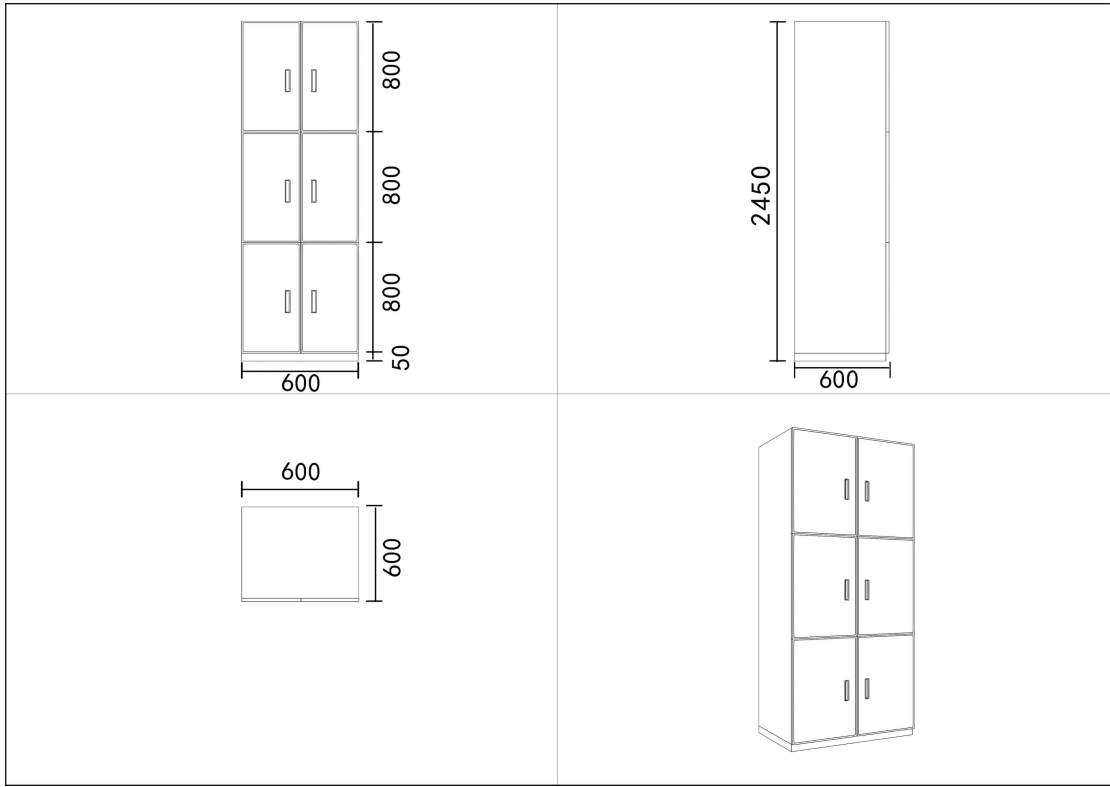

储物柜

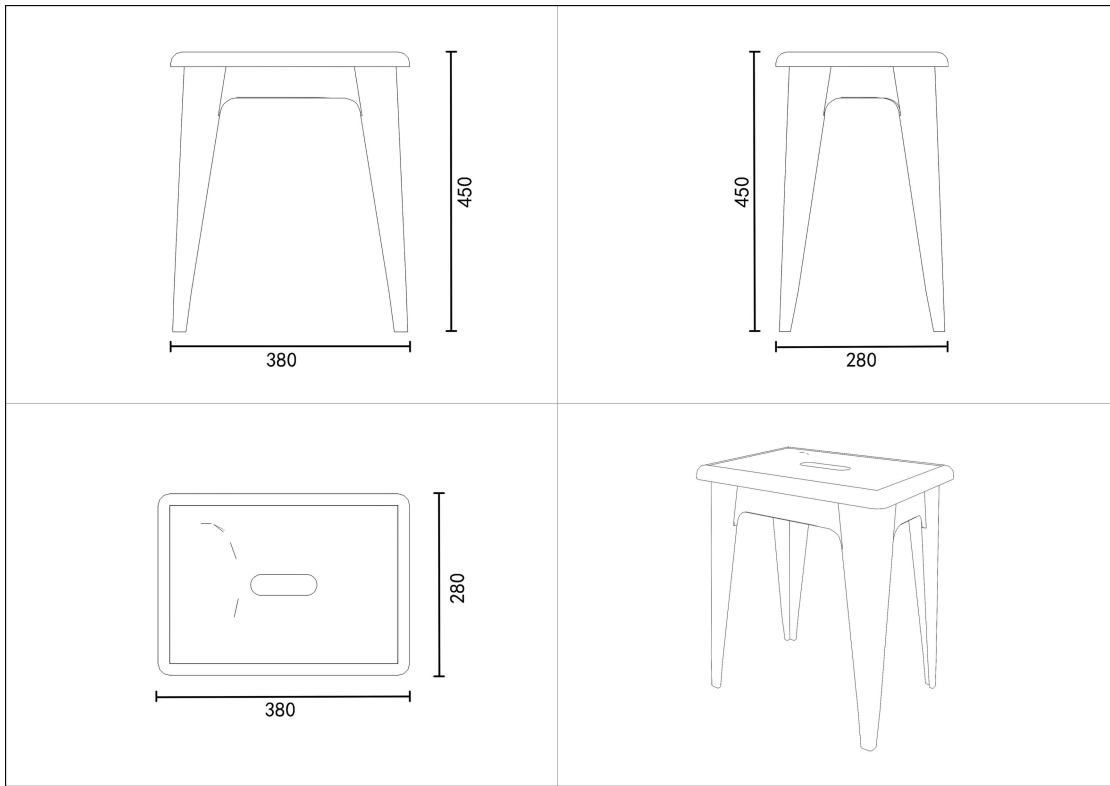

铝合金方凳

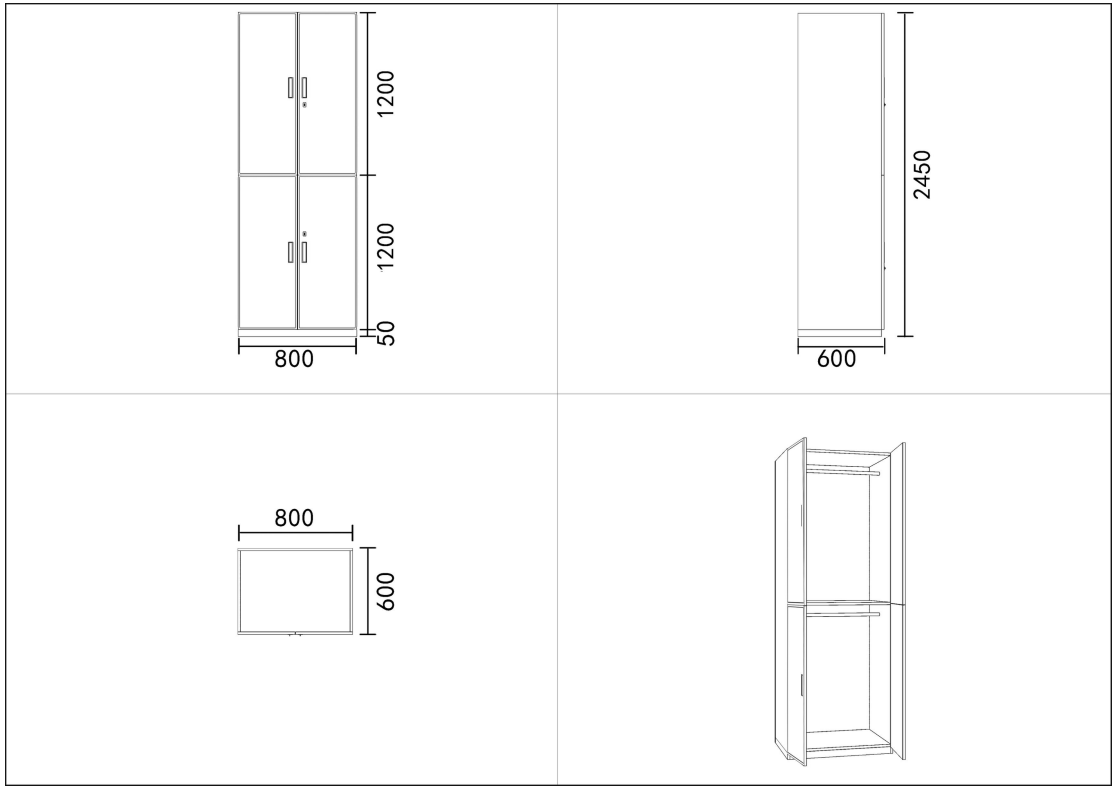

衣柜